

XSW
DMX Splitter / Booster,
Wireless DMX Transmitter &
Wireless DMX Receiver

User Manual

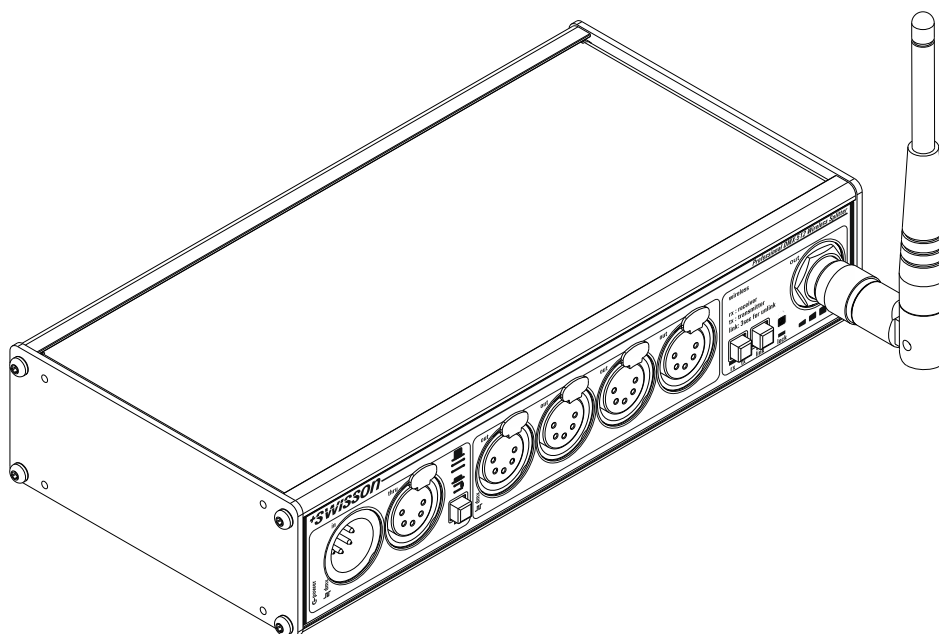

Index

Index.....	3
Introduction	4
Safety Information	5
Mains Connection	6
XSW Block Diagram	6
Transmission Technologies	6
Input Section	6
Input and "Thru" Port	7
Line Termination	7
Output Ports.....	8
Wireless Port and Operating Modes.....	8
Establishing a Wireless Link	9
Link LED	10
Multiple Links.....	11
Limits on Simultaneous Links	13
Position of the Antenna	13
Technical Data.....	15
Ordering Information	16

Introduction

The XSW combines CRMX™ wireless DMX technology with all of the advantages of the DMX splitters from SWISSON.

An XSW can be used as a DMX splitter, as a wireless DMX transmitter or as a wireless DMX receiver. The DMX splitter functionality is always available, regardless of whether the device is configured as a transmitter or as a receiver. If only the splitter functionality is used, the wireless part can be switched off. All ports, including the input port of the XSW are optically isolated.

Several XSW variants are available with various housings and connector types, which are using one of the most established wireless DMX transmission technologies; CRMX™ (by LumenRadio). This allows the XSW to be compatible with a vast majority of already existing wireless DMX equipment.

The built-in power supply allows for a reliable operation in a wide voltage range.

Fields of Application

- Architectural lighting
- TV sets
- Theme parks
- Theater
- Multimedia shows
- Concert lighting

Typical Application

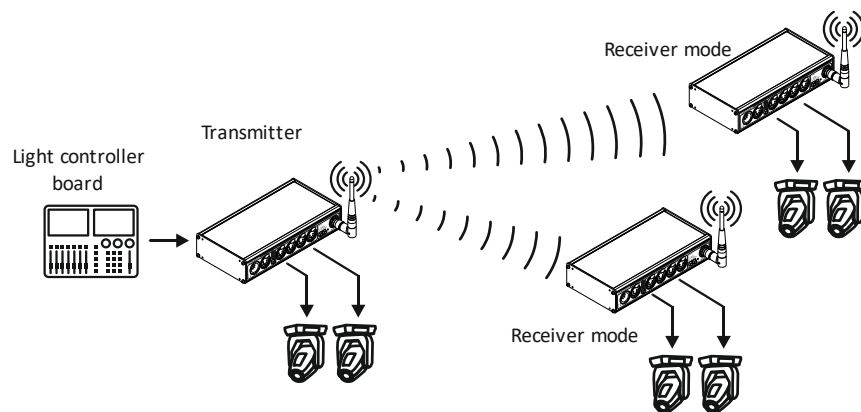

Unpacking

The XSW is packaged in a cardboard box including the following items:

- The device
- 1 antenna
- This user manual

Safety Information

Consider the following notes absolutely when you set up, connect and use the XSW.

This product is not for household use. Read this manual before operating the device, follow the safety precautions and observe all warnings in this manual.

Use this device only in accordance with local laws and regulations.

Safety Precautions

- Disconnect the device from AC power before removing any cover or part, including any fuse and when not in use.
- Ensure that the device is electrically connected to ground (earth).
- Use only a source of AC power that complies with local building and electrical codes and has both overload and ground fault (earth fault) protection.
- Before using the device, check that the power distribution equipment and cables are in perfect condition and rated for the current required of all connected devices.
- Isolate the device from power immediately if the power cable or the power plug is in any way damaged, defective or wet, or if they show signs of overheating.
- Do not expose the device to rain or moisture.
- Do not operate the device if any cover or component is missing, damaged or deformed.
- Refer any service operation not described in this manual to SWISSON.
- Provide unrestricted airflow around the device.
- Do not operate the device if the ambient temperature exceeds 55°C (131°F).
- Do not modify the device in any way not described in this manual or install other than genuine SWISSON parts.
- Do not attempt to bypass any fuse. Replace any defective fuse with one of the specified type and rating only.
- When suspending the device, ensure that the supporting structure and all hardware used can hold at least 10 times the weight of all devices suspended from them.
- When suspending the device, install a secondary attachment such as a safety cable that is approved by an official body such as TÜV as a safety attachment for the total weight it secures. The safety cable must comply with EN 60598-2-17 Section 17.6.6 and be capable of bearing a static suspended load 10 times the weight of the device.
- Make sure that any external cover and rigging hardware is securely fastened.
- Block access below the work area whenever installing, servicing or moving an overhead device.
- Do not use the device in areas where it is exposed to direct sunlight.

Mains Connection

The US versions are delivered by SWISSON with an "Edison Plug" (NEMA-5-15). These models are labeled with a type designation ending in "-US". International versions on the other hand, are delivered without any plug. SWISSON distributors or dealers may however deliver the devices with a country specific plug.



US Versions (-US suffix)

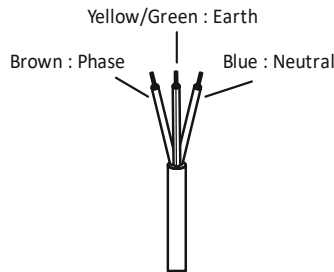

International Versions

	Wire (US System)	Wire (EU System)	Symbol
Live	Black	Brown	L
Neutral	White	Blue	N
Ground (Earth)	Green	Yellow/Green	⊥ or ⊕



Consult a qualified electrician if you have any doubts about proper installation.

The socket where the device is plugged in must be close to the device and easily accessible.

XSW Block Diagram

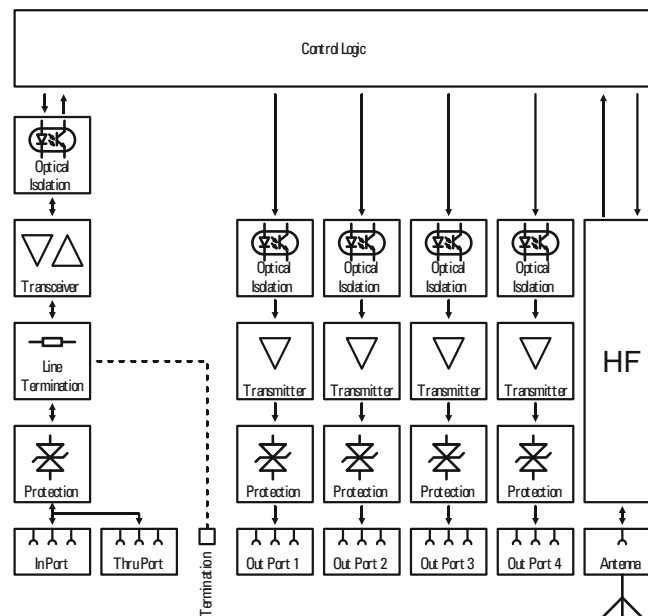





Transmission Technologies

The XWL is available with the following transmission type:

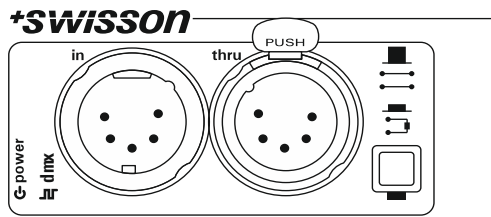
CRMTM (Cognitive Radio MultipleXer) by LumenRadio, which is very reliable and widely used in the professional lighting industry.

Input Section



- 
 The Power LED shows if the device is powered when the power supply unit of the XSW is working.
- 
 The Signal LED lights up in green, when a valid DMX signal is received at the input port. When a faulty DMX signal is received, the Signal LED lights up in red.
- 
 The XSW has a built-in line termination. This can be activated or deactivated by pressing the termination button.

Input and "Thru" Port

The "Thru" port is hardwired to the input port and allows to daisy-chain the devices even when the XSW is not powered. On XSW models with 5-pin XLR connectors, the pins 4 and 5 are also connected to the corresponding pins of the "Thru" port. On all other models, the pins 4 and 5 are not available.

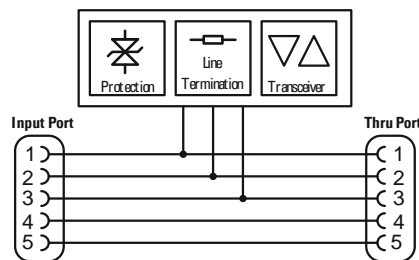

Line Termination

All XSW models have a built-in line termination. The termination is activated / deactivated by pressing the Line Termination button.

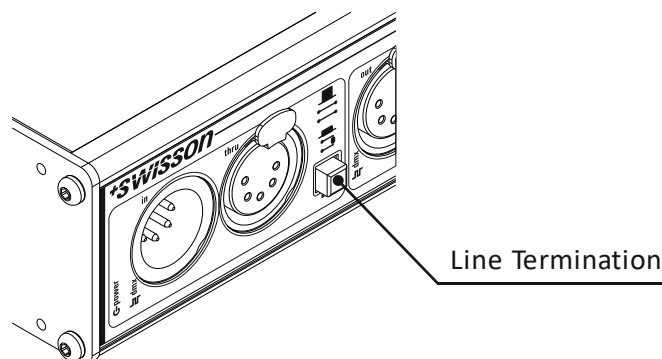

Output Ports

The output section

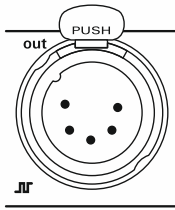

 The Signal LED of the output section lights up when DMX data is available at the output ports.

Each output port is individually optically isolated, meaning that it is totally isolated from the other output ports and from the input selection.

The pins 4 and 5 of the output ports on the models with 5-pin XLR connectors are not connected.

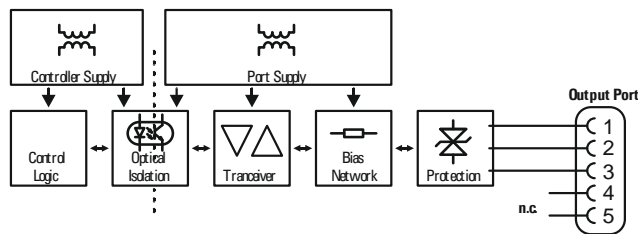

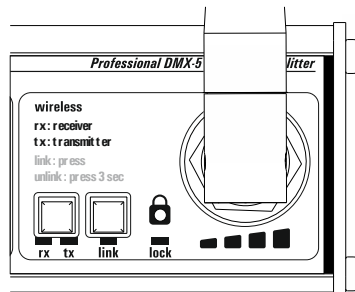

Wireless Port and Operating Modes



Operating Modes

The XWL has three operating modes as described below. The **Mode button**, which is located above the **Rx** and the **Tx LEDs**, is used to select the current operating mode.

-  **Splitter Only mode.** When both, the Rx LED and the Tx LED are off, the XSW operates as a splitter only. The wireless port is switched off.
-  **Receiver mode.** When the Rx LED is on, the XSW works as a wireless receiver. The received DMX data is forwarded to the DMX output ports. The DMX input port has no function in this mode.
-  **Transmitter mode.** When the Tx LED is on, the XSW operates as a wireless transmitter. The DMX data from the DMX input port is transmitted and is also available at the DMX output ports.

Wireless Port



Link button and Link LED. The Link button is used to link a transmitter to one or multiple receivers. The Link LED shows if the device is linked.



Signal strength indicator. In Receiver mode, four green LEDs display the signal strength. In Transmitter mode, they indicate that the transmitter is active by flashing alternately.

Locking the Device



Lock button and Lock LED. The Lock LED lights up in red when the **Lock function** is activated. In this case, the Mode and the Link buttons on the left of the Lock button are disabled. This may prevent an unintended manipulation of the operating mode or of the link status. The Lock button is used to enable/disable the Lock function. It is only accessible with the use of a tool like a paper clip.

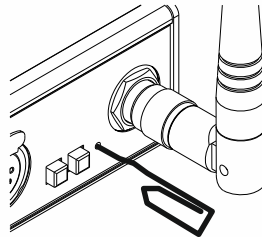

Establishing a Wireless Link

To transmit DMX data wirelessly, a transmitter and one or more receivers are used. The receiver has to be linked to the transmitter(s). This is achieved as shown below.

Transmitter mode

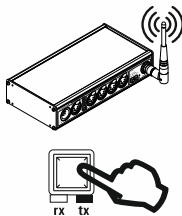

Receiver mode

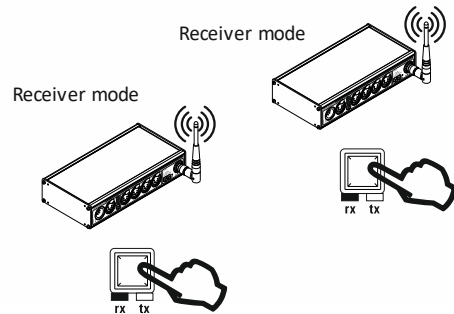

- 1) Press the Mode button of the device that is intended to be used as the transmitter repeatedly until the Tx LED is turned on in order to activate the Transmitter mode.

- 2) On each device that is intended to be used as a receiver: Put the device into receiver mode by pressing the mode button multiple times until the Rx LED lights up.

Transmitter mode

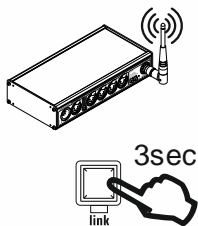

Receiver mode

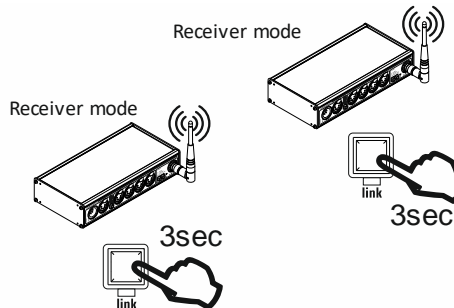

- 3) On transmitter: Press and hold the Link button for 3 seconds to unlink all devices previously linked to that transmitter.

- 4) On each receiver: Press and hold the link button for 3 seconds to unlink the device from any transmitter.

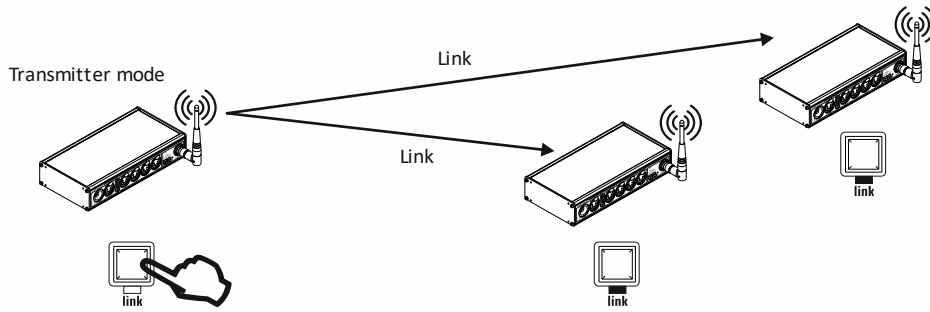

On transmitter: Press the link button to link all unlinked receivers in the range of the transmitter.

Link LED

The Link LED shows different status information depending on the model and operating mode.

XSW-TR-CRMX models

□ Led off ■ Led on

Transmitter mode



Linking in progress



Unlinking in progress



Linked (no DMX)



Linked (DMX OK)

Receiver mode

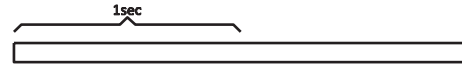

Unlinked



Linked (no connection to transmitter)



Linked (no DMX)



Linked (DMX OK)

XSW-TR-WDMX models

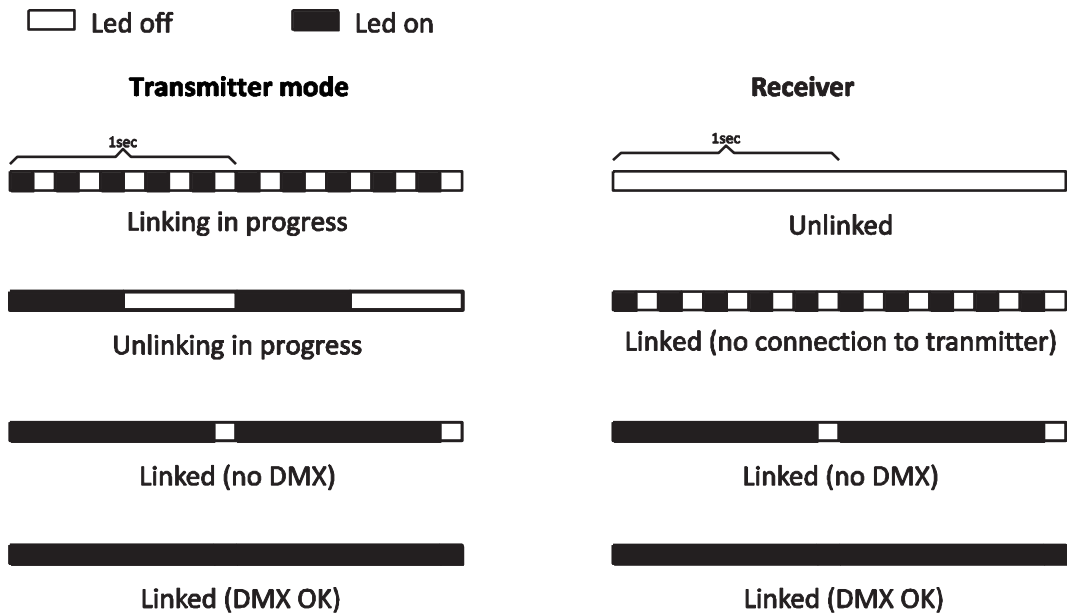

The Link LED is always off in Splitter Only mode.

Multiple Links

Multiple DMX universes can be transmitted wirelessly using several transmitters as described below.

- Put the units into their designated mode.

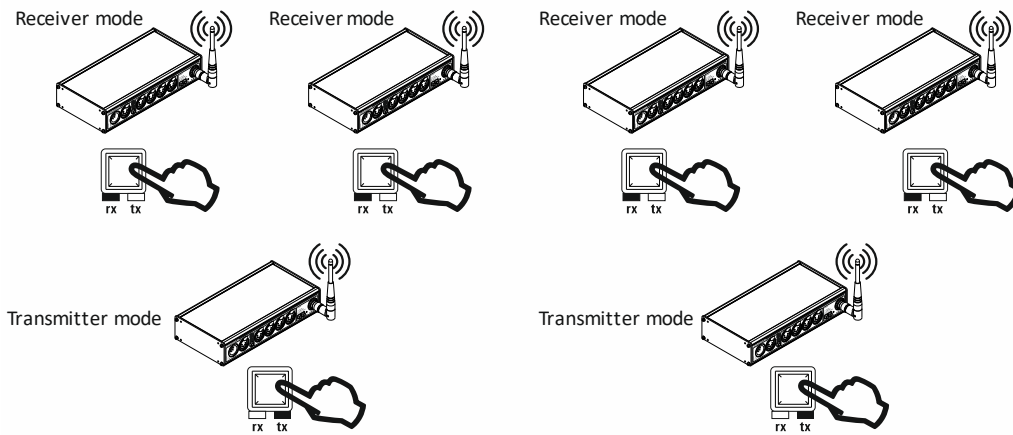

2) Unlink all devices from previous links.

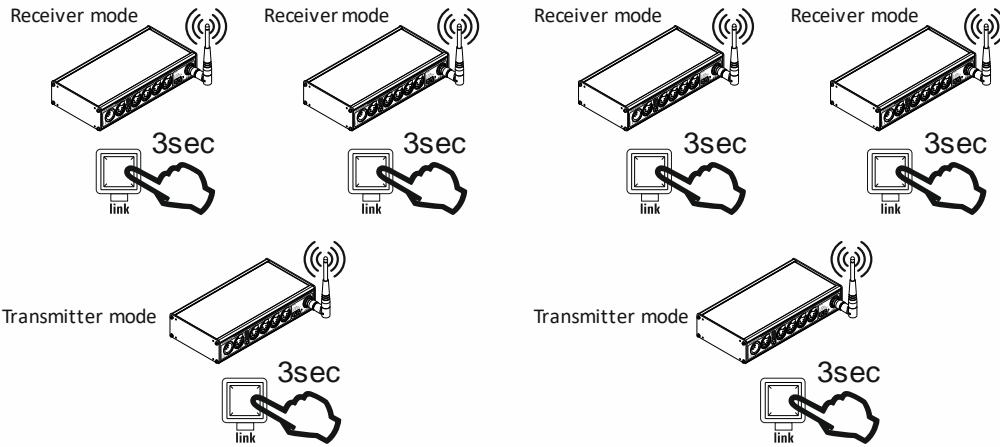

3) Link the first universe by pressing the link button on the first transmitter. It will link to all unlinked receivers.

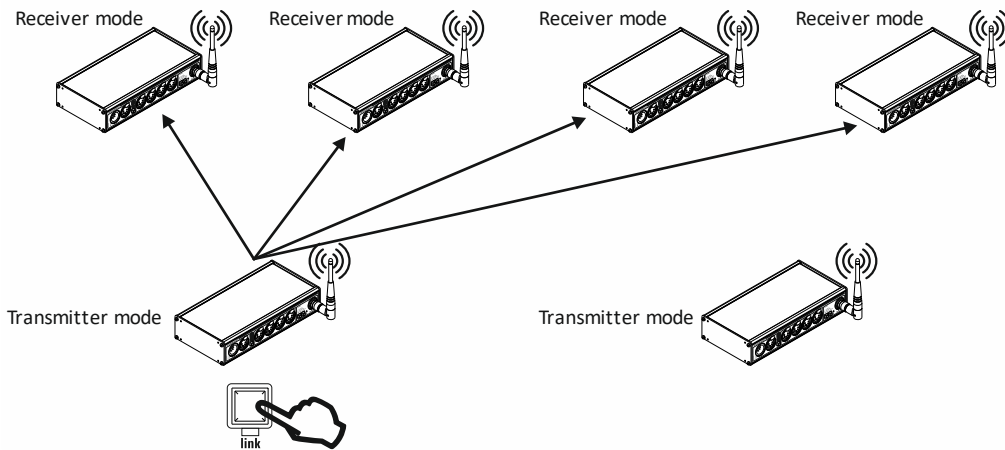

4) Unlink receivers you want to link to the second transmitter.

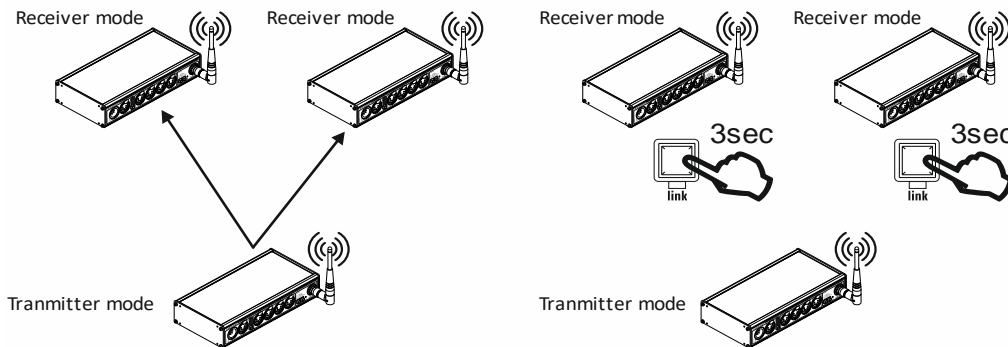

Note: You can switch the receivers you want to link to the second transmitter temporarily to Splitter only mode or you can switch them off. This prevents the need to unlink these receivers from the first transmitter.

5) Link the second universe by pressing the link button on the second transmitter. It will link to all unlinked receivers.

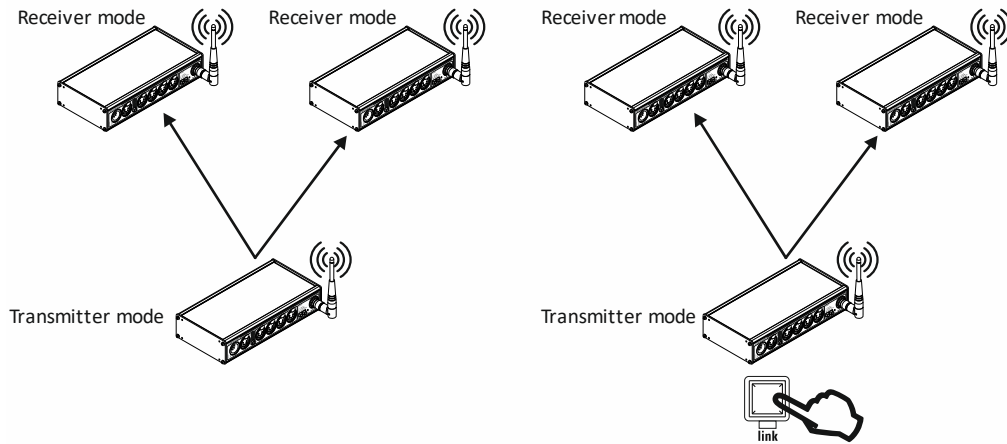

Limits on Simultaneous Links

Each transmitter needs bandwidth and there might also be a lot of other devices like Wi-Fi using the same frequency band. It's not recommended to use more than 4-6 transmitters on the same site.

There is no limitation for the number of receivers linked to a transmitter.

Position of the Antenna

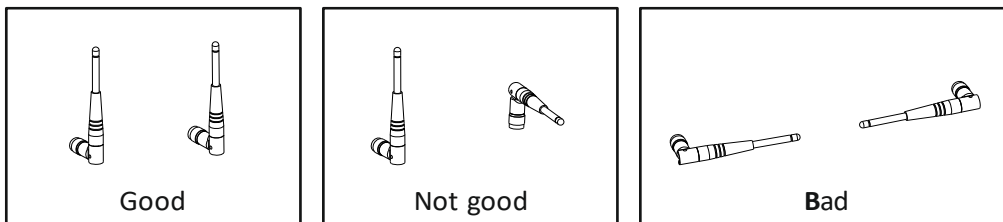

Try to position the antennas in parallel.

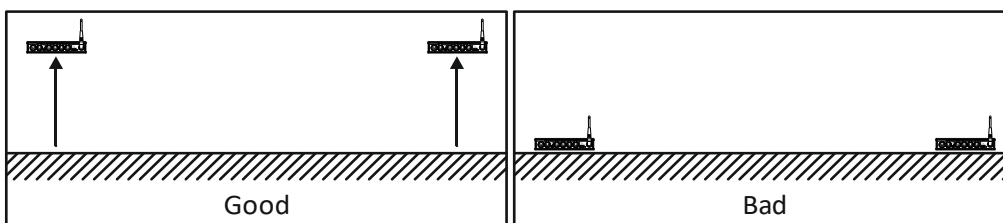

Avoid the operation of the XSW near the ground.

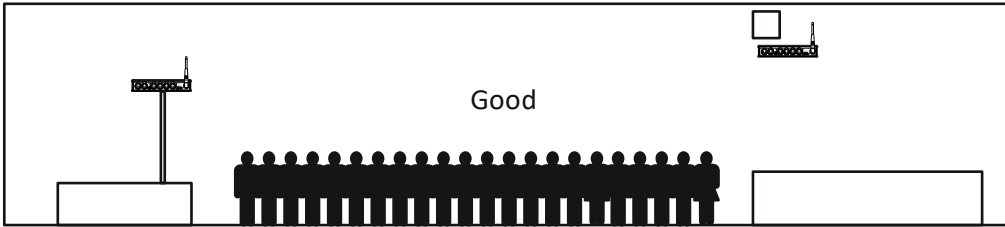
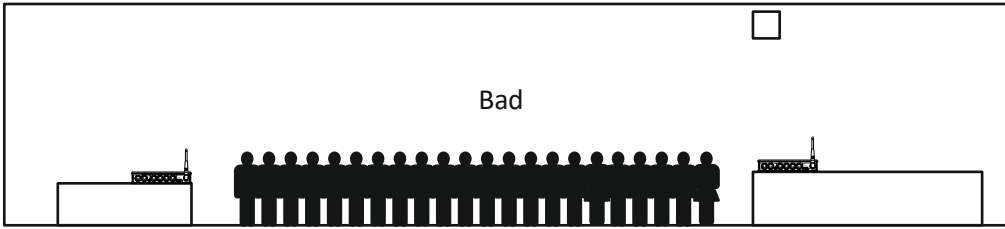

Try to place the antennas at an elevated location. A crowd will absorb the signal.

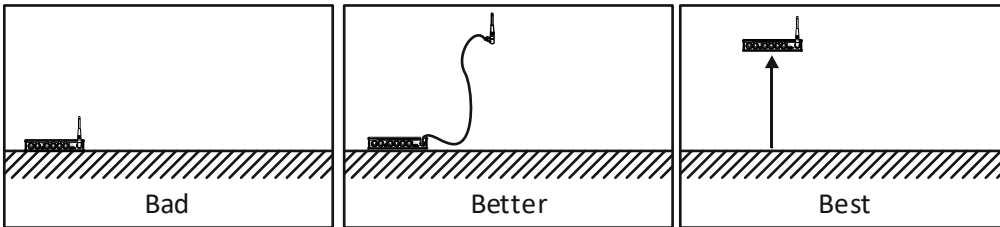

It is recommended to place the device itself at an elevated location rather than to use an antenna cable.

Technical Data

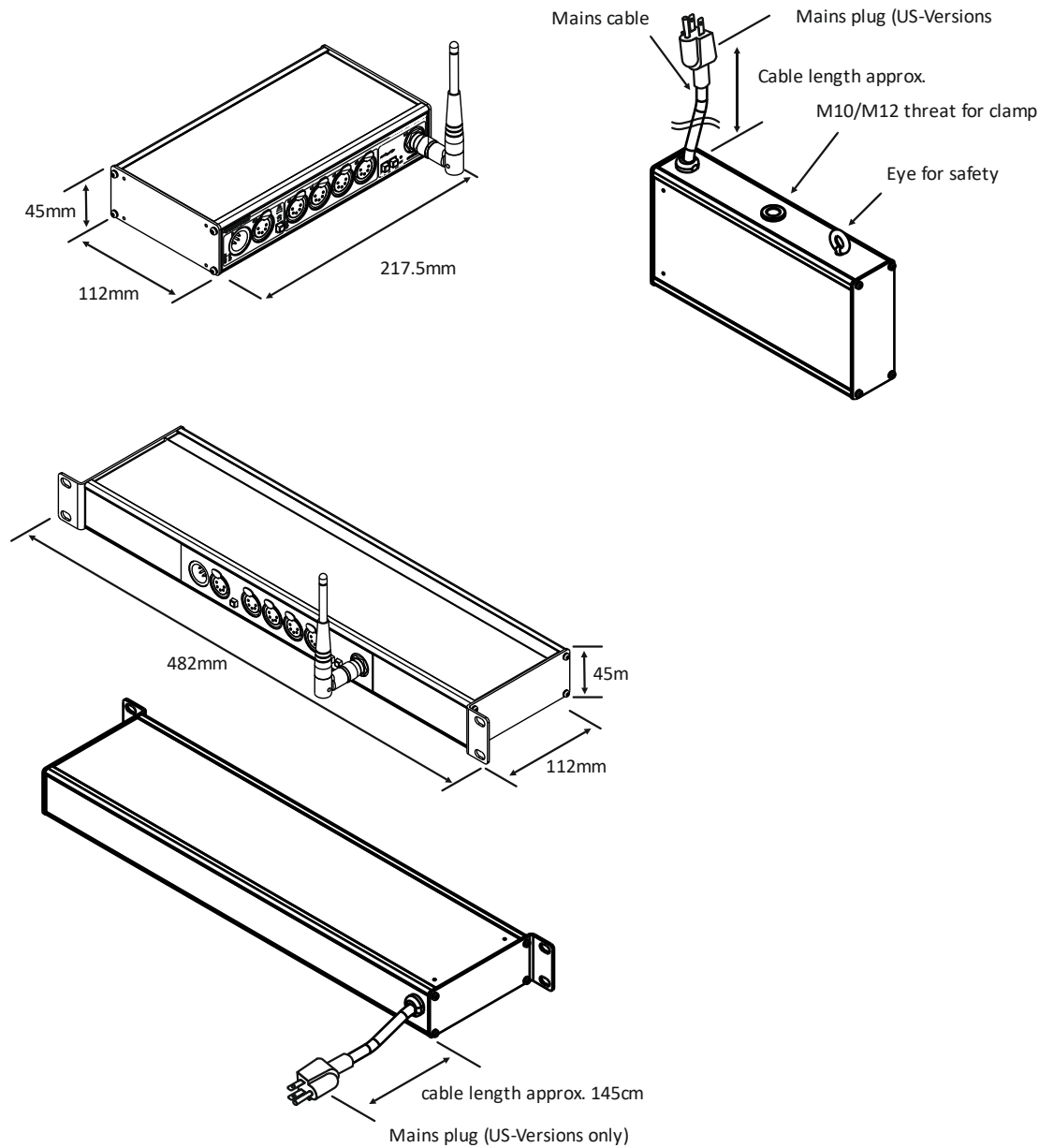

Ambient temperature	-17°C – 55°C (0°F – 131°F)
System latency	5 ms
Broadcast power (transmitter)	100 mW (20 dBm)
Radio frequency band	2.4 GHz
Mains supply	100-240 VAC 50/60 Hz
Power consumption	4 W
DMX.....	ANSI E1.11

Ordering Information

Box Versions

10 18 10	XSW-TR-CRMX-3B	Wireless DMX splitter, CRMX type, 3-pin XLR, box version.
10 18 11	XSW-TR-CRMX-5B	Wireless DMX splitter, CRMX type, 5-pin XLR, box version.

Rack Versions

10 18 20	XSW-TR-CRMX-3R	Wireless DMX splitter, CRMX type, 3-pin XLR, rack version.
10 18 21	XSW-TR-CRMX-5R	Wireless DMX splitter, CRMX type, 5-pin XLR, rack version.